

CircuiTikZ

version 0.4

Massimo A. Redaelli

May 4, 2015

Contents

1	Introduction	2
1.1	About	3
1.2	Loading the package	3
1.3	License	3
1.4	Feedback	3
1.5	Requirements	3
1.6	Incompatible packages	4
1.7	Introduction to version 0.3.0	4
1.8	Introduction to version 0.2.3	4
2	Package options	4
3	The components	6
3.1	Monopoles	7
3.2	Bipoles	9
3.2.1	Instruments	9
3.2.2	Basic resistive bipoles	9
3.2.3	Resistors and the like	10
3.2.4	Stationary sources	12
3.2.5	Diodes and such	13
3.2.6	Basic dynamical bipoles	15
3.2.7	Sinusoidal sources	16
3.2.8	Special sources	16
3.2.9	DC sources	17
3.2.10	Switch	17
3.2.11	HF components	17
3.3	Tripoles	19
3.3.1	Controlled sources	19
3.3.2	Transistors	21
3.3.3	HF	24
3.3.4	Switch	24
3.3.5	Other bipole-like tripoles	24
3.3.6	Misc	24
3.4	Double bipoles	25
3.5	Logic gates	26

3.6	Amplifiers	28
3.7	Support shapes	29
4	Usage	29
4.1	Labels	30
4.2	Currents	31
4.3	Voltages	32
	4.3.1 European style	32
	4.3.2 American style	33
4.4	Nodes	33
4.5	Special components	34
4.6	Integration with <code>siunitx</code>	36
4.7	Mirroring	36
4.8	Putting them together	37
5	Not only bipoles	37
5.1	Anchors	37
	5.1.1 Logical ports	37
	5.1.2 Transistors	38
	5.1.3 Other tripoles	40
	5.1.4 Operational amplifier	40
	5.1.5 Double bipoles	41
5.2	Input arrows	42
5.3	Transistor paths	43
6	Customization	44
6.1	Parameters	44
6.2	Components size	45
6.3	Colors	46
7	FAQ	48
8	Examples	49
9	Revision history	54
	Index of the components	57

1 Introduction

After two years of little exposure only on my personal website¹, I did a major rehaul-
ing of the code of `CircuitikZ`, fixing several problems and converting everything to
TikZ version 2.0.

I'm not too sure about the result, because my (La)TeX skills are much to be
improved, but it seems it's time for more user feedback. So, here it is...

I know the documentation is somewhat scant. Hope to have time to improve it a
bit.

¹Now the package is moved to its own git repository: <https://github.com/mredaelli/circuitikz>. Contributions are welcome.

1.1 About

This package provides a set of macros for naturally typesetting electrical and (some-what less naturally, perhaps) electronical networks.

It was born mainly for writing my own exercise book and exams sheets for the Elettrotecnica courses at Politecnico di Milano, Italy. I wanted a tool that was easy to use, with a lean syntax, native to \LaTeX , and supporting directly PDF output format.

So I based everything with the very impressive (if somewhat verbose at times) TikZ package.

1.2 Loading the package

\LaTeX	Con \TeX t ²
<code>\usepackage{circuitikz}</code>	<code>\usemodule[circuitikz]</code>

TikZ will be automatically loaded.

Circuitikz commands are just TikZ commands, so a minimum usage example would be:

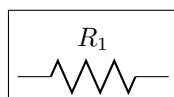

```
\tikz \draw (0,0) to[R=$R_1$] (2,0);
```

1.3 License

Copyright © 2007–2011 Massimo Redaelli. This package is author-maintained. Permission is granted to copy, distribute and/or modify this software under the terms of the \LaTeX Project Public License, version 1.3.1, or the GNU Public License. This software is provided ‘as is’, without warranty of any kind, either expressed or implied, including, but not limited to, the implied warranties of merchantability and fitness for a particular purpose.

1.4 Feedback

Much appreciated: ✉ <mailto:m.redaelli@gmail.com>. Although I don’t guarantee quick answers.

1.5 Requirements

- `tikz`, version ≥ 2 ;
- `xstring`, not older than 2009/03/13;
- `siunitx`, if using `siunitx` option.

²Con \TeX t support was added mostly thanks to Mojca Miklavc and Aditya Mahajan.

1.6 Incompatible packages

TikZ's own circuit library, which is based on CircuiTikZ, (re?)defines several styles used by this library. In order to have them work together I added the compatibility package option, which basically prefixes the names of all CircuiTikZ to [] styles with an asterisk.

So, if loaded with said option, one must write $(0,0)$ to[*R] $(2,0)$ and, for transistors on a path, $(0,0)$ to[*Tmos] $(2,0)$, and so on (but $(0,0)$ node [nmos] {}). See example at page 54.

1.7 Introduction to version 0.3.0

Probably nobody is hoping or caring for a new version of the package at this point, seeing how long it took me for this next release. But here it is, fixing a big problem (voltage labels in the wrong place, in some cases) and adding several components.

Thanks for bug reporting and suggesting improvements.

1.8 Introduction to version 0.2.3

Having waited a long time before updating the package, many feature requests piled on my desk. They should all be implemented now.

There are a number of backward incompatibilities—I'm sorry, but I had to make a choice in order not to have a schizophrenic interface. They are mostly, in my opinion, minor problems that can be dealt with with appropriate package options:

- potentiometer is now the standard resistor-with-arrow-in-the-middle; the old potentiometer is now known as variable resistor (or vR), similarly to variable inductor and variable capacitor;
- american inductor was not really the standard american inductor. The old american inductor has been renamed cute inductor;
- transformer, transformer core and variable inductor are now linked with the chosen type of inductor;
- styles for selecting shape variants (like [american resistors]) are now in the plural to avoid conflict with paths (like to[american resistor]).

2 Package options

Circuit people are very opinionated about their symbols. The package, left to its own devices, loads with drawing conventions that I like, so for instance you get this:

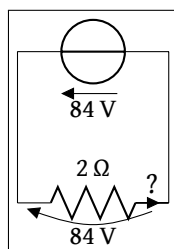

```
1 \begin{circuitikz}
2   \draw (0,0) to[R=2<\ohm>,i=?,v=84<\volt>] (2,0) ---
3         (2,2) to[V=84<\volt>] (0,2)
4         --- (0,0);
5 \end{circuitikz}
```

But if you really, *really* want your circuit ugly, you can load the package with:

LaTeX	ConTeXt
<code>\usepackage[american]{circuitikz}</code>	<code>\usemodule[circuitikz][american]</code>

and you get (don't blame me)

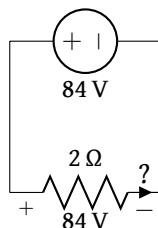

Here is the list of all the options:

- `europenvoltages`: uses arrows to define voltages, and uses european-style voltage sources;
- `americanvoltages`: uses `-` and `+` to define voltages, and uses american-style voltage sources;
- `europencurrents`: uses european-style current sources;
- `americancurrents`: uses american-style current sources;
- `europenresistors`: uses rectangular empty shape for resistors, as per european standards;
- `americanresistors`: uses zig-zag shape for resistors, as per american standards;
- `europeninductors`: uses rectangular filled shape for inductors, as per european standards;
- `americaninductors`: uses "4-bumps" shape for inductors, as per american standards;
- `cuteinductors`: uses my personal favorite, "pig-tailed" shape for inductors;
- `americanports`: uses triangular logic ports, as per american standards;
- `europenports`: uses rectangular logic ports, as per european standards;
- `americangfsgearrester`: uses round gas filled surge arresters, as per american standards;
- `europengfsgearrester`: uses rectangular gas filled surge arresters, as per european standards;
- `european`: equivalent to `europencurrents`, `europenvoltages`, `europenresistors`, `europeninductors`, `europenports`, `europengfsgearrester`;

- `american`: equivalent to `americancurrents`, `americanvoltages`, `americanresistors`, `americaninductors`, `americanports`, `americangfsurgearrester`;
- `siunitx`: integrates with `SIunitx` package. If labels, currents or voltages are of the form `#1<#2>` then what is shown is actually `\SI{#1}{#2}`;
- `nosiunitx`: labels are not interpreted as above;
- `fulldiodes`: the various diodes are drawn *and* filled by default, i.e. when using styles such as `diode`, `D`, `sD`, ... Un-filled diode can always be forced with `Do`, `sDo`, ...
- `emptydiodes`: the various diodes are drawn *but not* filled by default, i.e. when using styles such as `diode`, `D`, `sD`, ... Filled diode can always be forced with `D*`, `sD*`, ...
- `arrowmos`: pmos and nmos have arrows analogous to those of pnp and npn transistors;
- `noarrowmos`: pmos and nmos do not have arrows analogous to those of pnp and npn transistors;
- `straightlabels`: labels on bipoles are always printed straight up, i.e. with horizontal baseline;
- `rotatelabels`: labels on bipoles are always printed aligned along the bipole;
- `smartlabels`: labels on bipoles are rotated along the bipoles, unless the rotation is very close to multiples of 90°;
- `compatibility`: makes it possible to load `CircuiTikZ` and `TikZ` circuit library together.

The old options in the singular (like `american voltage`) are still available for compatibility, but are discouraged.

Loading the package with no options is equivalent to my own personal liking, that is to the following options:

```
[europeancurrents, europeanvoltages, americanresistors, cuteinductors,
americanports, nosiunitx, noarrowmos, smartlabels].
```

In `ConTeXt` the options are similarly specified: `current=european|american`, `voltage=european|american`, `resistor=american|european`, `inductor=cute|american|european`, `logic=american|european`, `siunitx=true|false`, `arrowmos=false|true`.

3 The components

Here follows the list of all the shapes defined by `CircuiTikZ`. These are all `pgf` nodes, so they are usable in both `pgf` and `TikZ`.

Each bipole (plus triac and thyristors) are shown using the following command, where `#1` is the name of the component³:

³If `#1` is the name of the bipole/the style, then the actual name of the shape is `#1shape`.

```
\begin{center}\begin{circuitikz} \draw
(0,0) to[ #1 ] (2,0)
; \end{circuitikz} \end{center}
```

The other shapes are shown with:

```
\begin{center}\begin{circuitikz} \draw
(0,0) node[ #1 ] {}
; \end{circuitikz} \end{center}
```

Please notice that for user convenience transistors can also be inputted using the syntax for bipoles. See section 5.3.

If using the `\tikzexternalize` feature, as of Tikz 2.1 all pictures must end with `\end{tikzpicture}`. Thus you *cannot* use the `circuitikz` environment. Which is ok: just use `tikzpicture`: everything will work there just fine.

3.1 Monopoles

- Ground (ground)



- Reference ground (rground)



- Signal ground (sground)



- Noiseless ground (nground)



- Protective ground (pground)



- Chassis ground⁴ (cground)



⁴These last three were contributed by Luigi «Liverpool»

- Antenna (antenna)



- Receiving antenna (rxantenna)

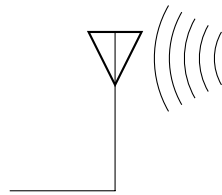

- Transmitting antenna (txantenna)

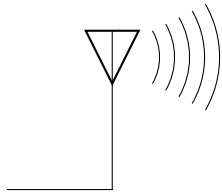

- Transmission line stub (tlinestub)

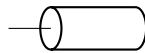

- VCC (vcc)



- match (match)



- LO⁵ (oscillator)



⁵These last three come from Stefan Erhardt's contribution of HF components

3.2 Bipoles

3.2.1 Instruments

- Ammeter (ammeter)

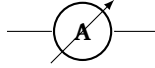

- Voltmeter (voltmeter)



- Ohmmeter (ohmmeter)

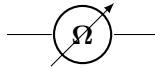

3.2.2 Basic resistive bipoles

- Short circuit (short)

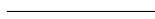

- Open circuit (open)

- Lamp (lamp)

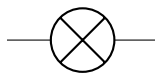

- Generic (symmetric) bipole (generic)

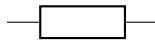

- Tunable generic bipole (tgeneric)

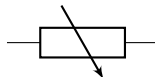

- Generic asymmetric bipole (ageneric)

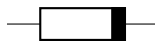

- Generic asymmetric bipole (full) (fullgeneric)



- Tunable generic bipole (full) (tfullgeneric)



- Memristor (memristor, or Mr)

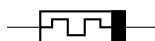

3.2.3 Resistors and the like

If (default behaviour) `americanresistors` option is active (or the style `[american resistors]` is used), the resistor is displayed as follows:

- Resistor (R, or `american resistor`)



- Variable resistor (vR, or `variable american resistor`)



- Potentiometer (pR, or `american potentiometer`)



If instead `europianresistors` option is active (or the style `[european resistors]` is used), the resistors, variable resistors and potentiometers are displayed as follows:

- Resistor (R, or `european resistor`)

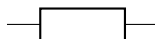

- Variable resistor (vR, or `european variable resistor`)

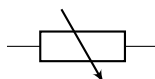

- Potentiometer (pR, or `european potentiometer`)

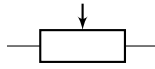

Other miscellaneous resistor-like devices:

- Varistor (varistor)

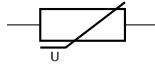

- Photoresistor (phR, or photoresistor)

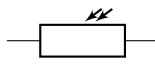

- Thermocouple (thermocouple)



- Thermistor (thR, or thermistor)



- PTC thermistor (thRp, or thermistor ptc)

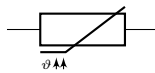

- NTC thermistor (thRn, or thermistor ntc)

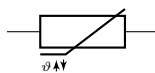

- Fuse (fuse)

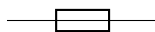

- Asymmetric fuse (afuse, or asymmetric fuse)

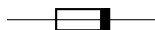

3.2.4 Stationary sources

- Battery (battery)

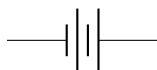

- Single battery cell (battery1)

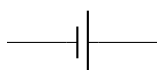

- Voltage source (european style) (european voltage source)

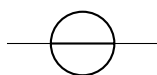

- Voltage source (american style) (american voltage source)

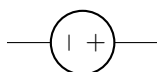

- Current source (european style) (european current source)



- Current source (american style) (american current source)

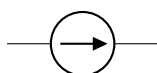

If (default behaviour) `europencurrents` option is active (or the style `[european currents]` is used), the shorthands `current source`, `isource`, and `I` are equivalent to european current source. Otherwise, if `americancurrents` option is active (or the style `[american currents]` is used) they are equivalent to american current source.

Similarly, if (default behaviour) `europeanvoltages` option is active (or the style `[european voltages]` is used), the shorthands `voltage source`, `vsource`, and `V` are equivalent to european voltage source. Otherwise, if `americanvoltages` option is active (or the style `[american voltages]` is used) they are equivalent to american voltage source.

3.2.5 Diodes and such

- Empty diode (empty diode, or Do)

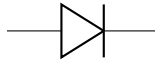

- Empty Schottky diode (empty Schottky diode, or sDo)

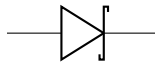

- Empty Zener diode (empty Zener diode, or zDo)

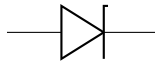

- Empty tunnel diode (empty tunnel diode, or tDo)

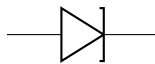

- Empty photodiode (empty photodiode, or pDo)

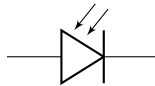

- Empty led (empty led, or leDo)

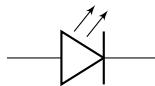

- Empty varcap (empty varcap, or VCo)

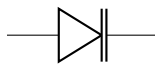

- Full diode (full diode, or D*)

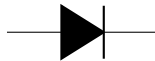

- Full Schottky diode (full Schottky diode, or sD*)

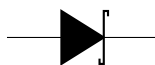

- Full Zener diode (full Zener diode, or zD*)



- Full tunnel diode (full tunnel diode, or tD*)

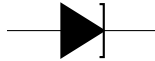

- Full photodiode (full photodiode, or pD*)

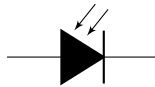

- Full led (full led, or leD*)

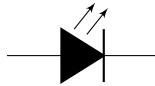

- Full varcap (full varcap, or VC*)



The options `fulldiodes` and `emptydiodes` (and the styles `[full diodes]` and `[empty diodes]`) define which shape will be used by abbreviated commands such that `D`, `sD`, `zD`, `tD`, `pD`, `leD`, and `VC`.

- Squid (squid)

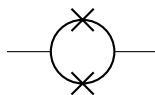

- Barrier (barrier)



- European gas filled surge arrester (european gas filled surge arrester)



- American gas filled surge arrester (american gas filled surge arrester)



If (default behaviour) `europiangfsurgearrester` option is active (or the style `[european gas filled surge arrester]` is used), the shorthands `gas filled surge arrester` and `gf surge arrester` are equivalent to the european version of the component.

If otherwise `americangfsurgearrester` option is active (or the style `[american gas filled surge arrester]` is used), the shorthands `gas filled surge arrester` and `gf surge arrester` are equivalent to the american version of the component.

3.2.6 Basic dynamical bipoles

- Capacitor (`capacitor`, or `C`)

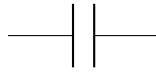

- Polar capacitor (`polar capacitor`, or `pC`)

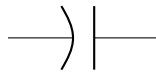

- Variable capacitor (`variable capacitor`, or `vC`)

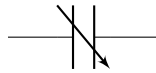

If (default behaviour) `cuteinductors` option is active (or the style `[cute inductors]` is used), the inductors are displayed as follows:

- Inductor (`L`, or `cute inductor`)



- Variable inductor (`vL`, or `variable cute inductor`)

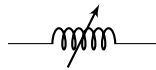

If `americaninductors` option is active (or the style `[american inductors]` is used), the inductors are displayed as follows:

- Inductor (`L`, or `american inductor`)



- Variable inductor (`vL`, or `variable american inductor`)



Finally, if `europainductors` option is active (or the style `[european inductors]` is used), the inductors are displayed as follows:

- Inductor (`L`, or `european inductor`)



- Variable inductor (`vL`, or `variable european inductor`)



There is also a transmission line:

- Transmission line (`TL`, or `transmission line`, `tline`)

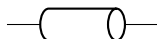

3.2.7 Sinusoidal sources

Here because I was asked for them. But how do you distinguish one from the other?!

- Sinusoidal voltage source (`sinusoidal voltage source`, or `vsourcesin`, `sV`)

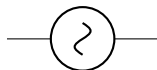

- Sinusoidal current source (`sinusoidal current source`, or `isourcesin`, `sI`)

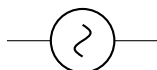

3.2.8 Special sources

- Square voltage source (`square voltage source`, or `vsourcesquare`, `sqV`)

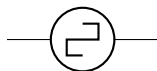

- Square voltage source (`vsourcetri`)

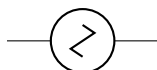

- Empty voltage source (`esource`)

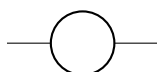

3.2.9 DC sources

- DC voltage source (dcvsource)

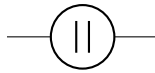

- DC current source (dcisource)

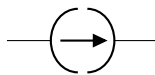

3.2.10 Switch

- Switch (switch, or spst)



- Closing switch (closing switch, or cspst)



- Opening switch (opening switch, or ospst)



- Push button (push button)

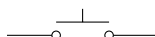

3.2.11 HF components

Contributed by Stefan Erhardt.

- generic two port⁶ (twoport)

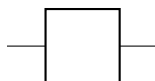

- vco (vco)

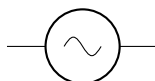

- bandpass (bandpass)

⁶To specify text to be put in the component: twoport [t=text]:

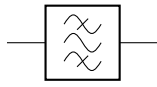

• highpass (highpass)

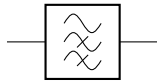

• lowpass (lowpass)

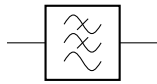

• A/D converter (adc)

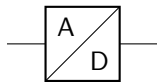

• D/A converter (dac)

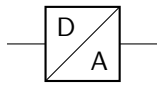

• DSP (dsp)

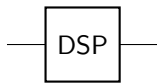

• FFT (fft)

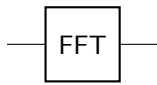

• amplifier (amp)

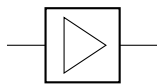

• VGA (vamp)

- π attenuator (piattenuator)

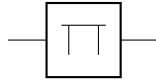

- var. π attenuator (vpiattenuator)

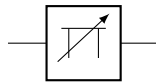

- T attenuator (tattenuator)

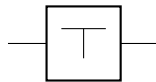

- var. T attenuator (vtattenuator)

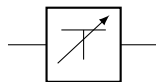

- phase shifter (phaseshifter)



- var. phase shifter (vphaseshifter)

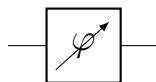

- detector (detector)

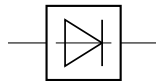

3.3 Tripoles

3.3.1 Controlled sources

Admittedly, graphically they are bipoles. But I couldn't...

- Controlled voltage source (european style) (european controlled voltage source)

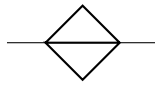

- Controlled voltage source (american style) (american controlled voltage source)

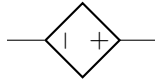

- Controlled current source (european style) (european controlled current source)

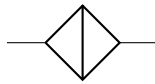

- Controlled current source (american style) (american controlled current source)

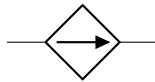

If (default behaviour) `europencurrents` option is active (or the style `[european currents]` is used), the shorthands controlled current source, `cisource`, and `cI` are equivalent to european controlled current source. Otherwise, if `americancurrents` option is active (or the style `[american currents]` is used) they are equivalent to american controlled current source.

Similarly, if (default behaviour) `europenvoltages` option is active (or the style `[european voltages]` is used), the shorthands controlled voltage source, `cvsources`, and `cV` are equivalent to european controlled voltage source. Otherwise, if `americenvoltages` option is active (or the style `[american voltages]` is used) they are equivalent to american controlled voltage source.

- Controlled sinusoidal voltage source (controlled sinusoidal voltage source, or controlled `vsourcesin`, `cvsourcesin`, `csV`)

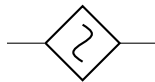

- Controlled sinusoidal current source (controlled sinusoidal current source, or controlled `isourcesin`, `cisourcesin`, `csI`)

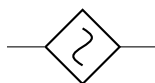

3.3.2 Transistors

- nmos (nmos)

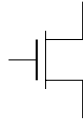

- pmos (pmos)

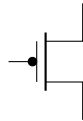

- npn (npn)

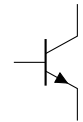

- pnp (pnp)

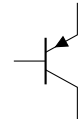

- npigt (nigt)

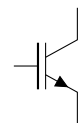

- pigbt (pigbt)

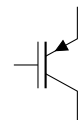

If the option `arrowmos` is used (or after the command `\ctikzset{tripoles/mos style/arrows}` is given), this is the output:

- nmos (nmos)

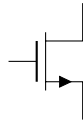

- pmos (pmos)

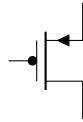

nfets and pfets have been incorporated based on code provided by Clemens Helfmeier and Theodor Borsche:

- nfet (nfet)

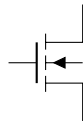

- nigfete (nigfete)

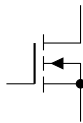

- nigfetebulk (nigfetebulk)

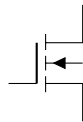

- nigfetd (nigfetd)

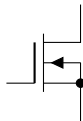

- pfet (pfet)

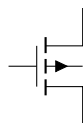

- pigfete (pigfete)

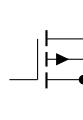

- pigfetebulk (pigfetebulk)

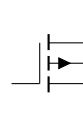

- pigfetd (pigfetd)

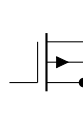

njfet and pjfet have been incorporated based on code provided by Danilo Piazzalunga:

- njfet (njfet)

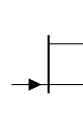

- pjfet (pjfet)

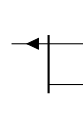

isfet

- isfet (isfet)

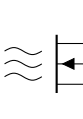

3.3.3 HF

These come from Stefan Erhardt's contribution of HF components.

- circulator (circulator)



- wilkinson divider (wilkinson)

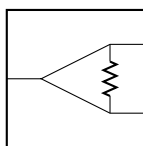

3.3.4 Switch

- spdt (spdt)



- Toggle switch (toggle switch)



3.3.5 Other bipole-like tripoles

The following tripoles are entered with the usual command of the form

- triac (triac, or Tr)

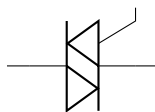

- thyristor (thyristor, or Ty)

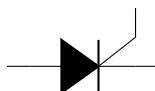

3.3.6 Misc

- Mixer (mixer)



3.4 Double bipoles

Transformers automatically use the inductor shape currently selected. These are the three possibilities:

- Transformer (cute inductor) (transformer)

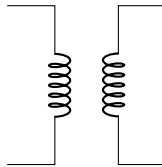

- Transformer (american inductor) (transformer)

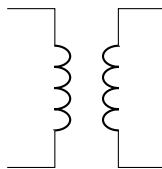

- Transformer (european inductor) (transformer)

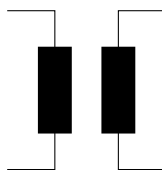

Transformers with core are also available:

- Transformer core (cute inductor) (transformer core)

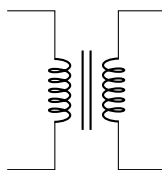

- Transformer core (american inductor) (transformer core)

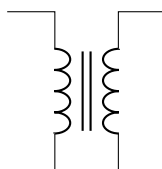

- Transformer core (european inductor) (transformer core)

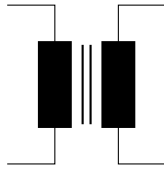

- Gyrator (gyrator)

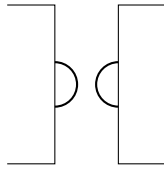

- Coupler (coupler)

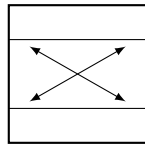

- Coupler, 2 (coupler2)

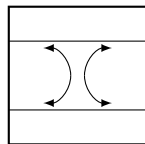

3.5 Logic gates

- American and port (american and port)

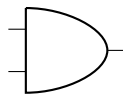

- American or port (american or port)

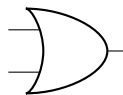

- American not port (american not port)

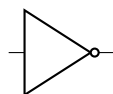

- American nand port (american nand port)

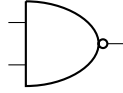

- American nor port (american nor port)

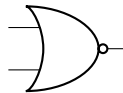

- American xor port (american xor port)

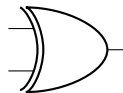

- American xnor port (american xnor port)

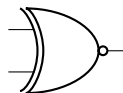

- European and port (european and port)

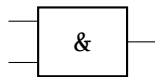

- European or port (european or port)

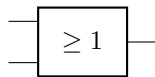

- European not port (european not port)

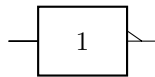

- European nand port (european nand port)

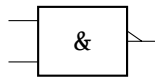

- European nor port (european nor port)

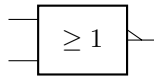

- European xor port (european xor port)

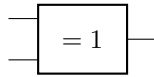

- European xnor port (european xnor port)

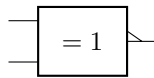

If (default behaviour) `americanports` option is active (or the style `[american ports]` is used), the shorthands `and port`, `or port`, `not port`, `nand port`, `not port`, `xor port`, and `xnor port` are equivalent to the american version of the respective logic port.

If otherwise `europianports` option is active (or the style `[european ports]` is used), the shorthands `and port`, `or port`, `not port`, `nand port`, `not port`, `xor port`, and `xnor port` are equivalent to the european version of the respective logic port.

3.6 Amplifiers

- Operational amplifier (op amp)

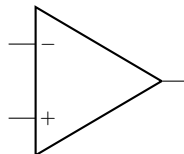

- Fully differential operational amplifier⁷ (fd op amp)

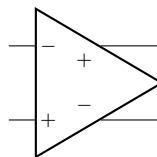

- transconductance amplifier (gm amp)

⁷Contributed by Kristofer M. Monisit.

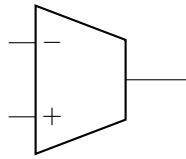

- Plain amplifier (`plain amp`)

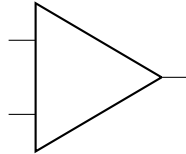

- Buffer (`buffer`)

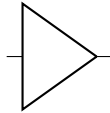

3.7 Support shapes

- Arrows (current and voltage) (`currarrow`)



- Connected terminal (`circ`)



- Unconnected terminal (`ocirc`)



4 Usage

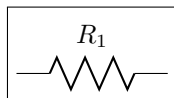

```

1 \begin{circuitikz}
2   \draw (0,0) to[R, l=$R_1$] (2,0);
3 \end{circuitikz}

```

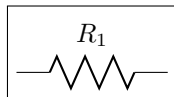

```

1 \begin{circuitikz}
2   \draw (0,0) to[R=$R_1$] (2,0);
3 \end{circuitikz}

```



```

1 \begin{circuitikz}
2   \draw (0,0) to[R, i=$i_1$] (2,0);
3 \end{circuitikz}

```

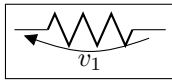

```

1 \begin{circuitikz}
2   \draw (0,0) to[R, v=$v_1$] (2,0);
3 \end{circuitikz}

```

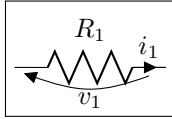

```

1 \begin{circuitikz}
2   \draw (0,0) to[R=$R_1$, i=$i_1$, v=$v_1$] (2,0);
3 \end{circuitikz}

```

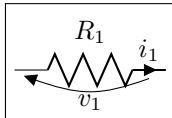

```

1 \begin{circuitikz}
2   \draw (0,0) to[R=$R_1$, i=$i_1$, v=$v_1$] (2,0);
3 \end{circuitikz}

```

Long names/styles for the bipoles can be used:

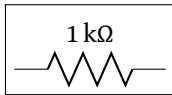

```

1 \begin{circuitikz} \draw
2   (0,0) to[resistor=1<\kilo\ohm>] (2,0)
3 ;\end{circuitikz}

```

4.1 Labels

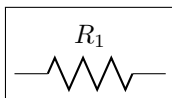

```

1 \begin{circuitikz}
2   \draw (0,0) to[R, l^=$R_1$] (2,0);
3 \end{circuitikz}

```

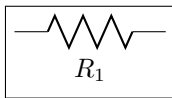

```

1 \begin{circuitikz}
2   \draw (0,0) to[R, l_=$R_1$] (2,0);
3 \end{circuitikz}

```

The default orientation of labels is controlled by the options `smartlabels`, `rotatelabels` and `straightlabels` (or the corresponding `label/align` keys). Here are examples to see the differences:

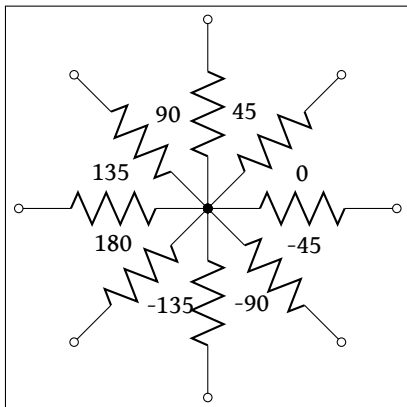

```

1 \begin{circuitikz}
2   \ctikzset {label/align = straight}
3   \def\DIR{0,45,90,135,180,-90,-45,-135}
4   \foreach \i in \DIR {
5     \draw (0,0) to[R=\i, *-o] (\i :2.5);
6   }
7 \end{circuitikz}

```

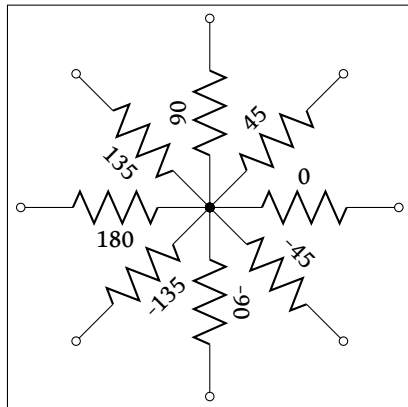

```

1 \begin{circuitikz}
2 \ctikzset{label/align = rotate}
3 \def\DIR{0,45,90,135,180,-90,-45,-135}
4 \foreach \i in \DIR {
5   \draw (0,0) to[R=\i, *-o] (\i :2.5);
6 }
7 \end{circuitikz}

```

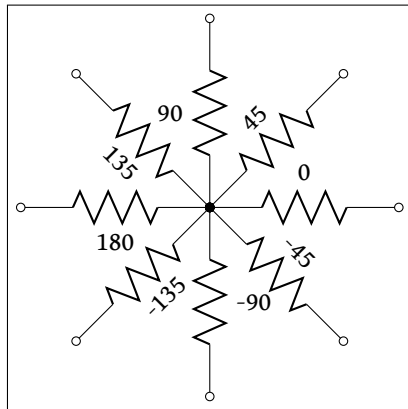

```

1 \begin{circuitikz}
2 \ctikzset{label/align = smart}
3 \def\DIR{0,45,90,135,180,-90,-45,-135}
4 \foreach \i in \DIR {
5   \draw (0,0) to[R=\i, *-o] (\i :2.5);
6 }
7 \end{circuitikz}

```

4.2 Currents



```

1 \begin{circuitikz}
2   \draw (0,0) to[R, i^>=$i_1$] (2,0);
3 \end{circuitikz}

```

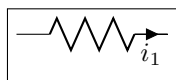

```

1 \begin{circuitikz}
2   \draw (0,0) to[R, i_>=$i_1$] (2,0);
3 \end{circuitikz}

```



```

1 \begin{circuitikz}
2   \draw (0,0) to[R, i^<=$i_1$] (2,0);
3 \end{circuitikz}

```

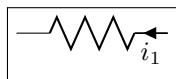

```

1 \begin{circuitikz}
2   \draw (0,0) to[R, i_<=$i_1$] (2,0);
3 \end{circuitikz}

```



```

1 \begin{circuitikz}
2   \draw (0,0) to[R, i>^=$i_1$] (2,0);
3 \end{circuitikz}

```

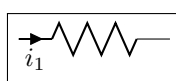

```

1 \begin{circuitikz}
2   \draw (0,0) to[R, i>_=$i_1$] (2,0);
3 \end{circuitikz}

```



```

1 \begin{circuitikz}
2   \draw (0,0) to[R, i<^=$i_1$] (2,0);
3 \end{circuitikz}

```



```

1 \begin{circuitikz}
2   \draw (0,0) to[R, i<_=$i_1$] (2,0);
3 \end{circuitikz}

```

Also



```

1 \begin{circuitikz}
2   \draw (0,0) to[R, i<_=$i_1$] (2,0);
3 \end{circuitikz}

```



```

1 \begin{circuitikz}
2   \draw (0,0) to[R, i>_=$i_1$] (2,0);
3 \end{circuitikz}

```



```

1 \begin{circuitikz}
2   \draw (0,0) to[R, i^=$i_1$] (2,0);
3 \end{circuitikz}

```



```

1 \begin{circuitikz}
2   \draw (0,0) to[R, i_=$i_1$] (2,0);
3 \end{circuitikz}

```

4.3 Voltages

4.3.1 European style

The default, with arrows. Use option `europeanvoltages` or style `[european voltages]`.

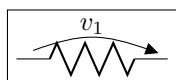

```

1 \begin{circuitikz}[european voltages]
2   \draw (0,0) to[R, v^>=$v_1$] (2,0);
3 \end{circuitikz}

```

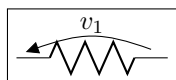

```

1 \begin{circuitikz}[european voltages]
2   \draw (0,0) to[R, v^<=$v_1$] (2,0);
3 \end{circuitikz}

```

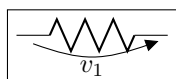

```

1 \begin{circuitikz}[european voltages]
2   \draw (0,0) to[R, v_>=$v_1$] (2,0);
3 \end{circuitikz}

```

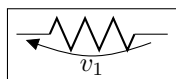

```

1 \begin{circuitikz}[european voltages]
2   \draw (0,0) to[R, v_<=$v_1$] (2,0);
3 \end{circuitikz}

```

4.3.2 American style

For those who like it (not me). Use option `americanvoltage` or set `[american voltages]`.

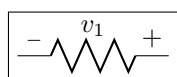

```
1 \begin{ circuitikz }[american voltages]
2   \draw (0,0) to[R, v^>=$v_1$] (2,0);
3 \end{ circuitikz }
```

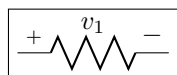

```
1 \begin{ circuitikz }[american voltages]
2   \draw (0,0) to[R, v^<=$v_1$] (2,0);
3 \end{ circuitikz }
```

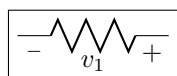

```
1 \begin{ circuitikz }[american voltages]
2   \draw (0,0) to[R, v_>=$v_1$] (2,0);
3 \end{ circuitikz }
```

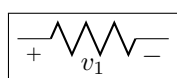

```
1 \begin{ circuitikz }[american voltages]
2   \draw (0,0) to[R, v_<=$v_1$] (2,0);
3 \end{ circuitikz }
```

4.4 Nodes



```
1 \begin{ circuitikz }
2   \draw (0,0) to[R, o-o] (2,0);
3 \end{ circuitikz }
```



```
1 \begin{ circuitikz }
2   \draw (0,0) to[R, -o] (2,0);
3 \end{ circuitikz }
```



```
1 \begin{ circuitikz }
2   \draw (0,0) to[R, o-] (2,0);
3 \end{ circuitikz }
```



```
1 \begin{ circuitikz }
2   \draw (0,0) to[R, *-*] (2,0);
3 \end{ circuitikz }
```



```
1 \begin{ circuitikz }
2   \draw (0,0) to[R, -*] (2,0);
3 \end{ circuitikz }
```



```
1 \begin{ circuitikz }
2   \draw (0,0) to[R, *-] (2,0);
3 \end{ circuitikz }
```

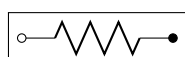

```
1 \begin{ circuitikz }
2   \draw (0,0) to[R, o-*] (2,0);
3 \end{ circuitikz }
```



```
1 \begin{ circuitikz }
2   \draw (0,0) to[R, *-o] (2,0);
3 \end{ circuitikz }
```

4.5 Special components

For some components label, current and voltage behave as one would expect:

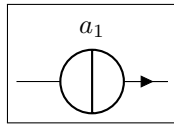

```
1 \begin{circuitikz}
2   \draw (0,0) to[I=$a_1$] (2,0);
3 \end{circuitikz}
```

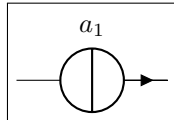

```
1 \begin{circuitikz}
2   \draw (0,0) to[I, i=$a_1$] (2,0);
3 \end{circuitikz}
```

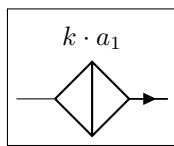

```
1 \begin{circuitikz}
2   \draw (0,0) to[CI=$k\cdot a_1$] (2,0);
3 \end{circuitikz}
```

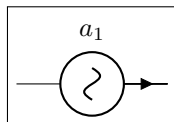

```
1 \begin{circuitikz}
2   \draw (0,0) to[sI=$a_1$] (2,0);
3 \end{circuitikz}
```

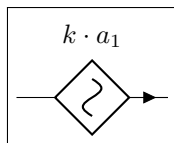

```
1 \begin{circuitikz}
2   \draw (0,0) to[CSI=$k\cdot a_1$] (2,0);
3 \end{circuitikz}
```

The following results from using the option `americancurrent` or using the style `[american currents]`.

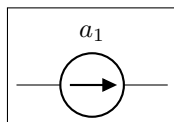

```
1 \begin{circuitikz}[american currents]
2   \draw (0,0) to[I=$a_1$] (2,0);
3 \end{circuitikz}
```

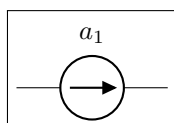

```
1 \begin{circuitikz}[american currents]
2   \draw (0,0) to[I, i=$a_1$] (2,0);
3 \end{circuitikz}
```

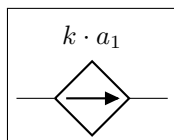

```
1 \begin{circuitikz}[american currents]
2   \draw (0,0) to[CI=$k\cdot a_1$] (2,0);
3 \end{circuitikz}
```

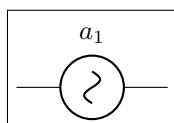

```
1 \begin{circuitikz}[american currents]
2   \draw (0,0) to[sI=$a_1$] (2,0);
3 \end{circuitikz}
```

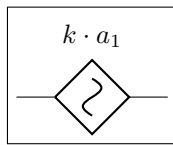

```

1 \begin{circuitikz}[american currents]
2   \draw (0,0) to[csi=$k\cdot a_1$] (2,0);
3 \end{circuitikz}

```

The same holds for voltage sources:

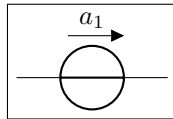

```

1 \begin{circuitikz}
2   \draw (0,0) to[V=$a_1$] (2,0);
3 \end{circuitikz}

```

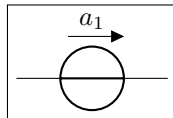

```

1 \begin{circuitikz}
2   \draw (0,0) to[V, v=$a_1$] (2,0);
3 \end{circuitikz}

```

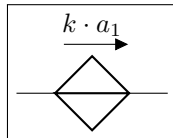

```

1 \begin{circuitikz}
2   \draw (0,0) to[cV=$k\cdot a_1$] (2,0);
3 \end{circuitikz}

```

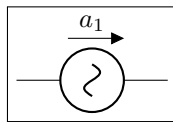

```

1 \begin{circuitikz}
2   \draw (0,0) to[sV=$a_1$] (2,0);
3 \end{circuitikz}

```

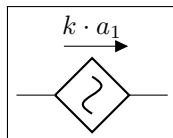

```

1 \begin{circuitikz}
2   \draw (0,0) to[csV=$k\cdot a_1$] (2,0);
3 \end{circuitikz}

```

The following results from using the option `americanvoltage` or the style `[american voltages]`.

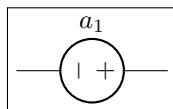

```

1 \begin{circuitikz}[american voltages]
2   \draw (0,0) to[V=$a_1$] (2,0);
3 \end{circuitikz}

```

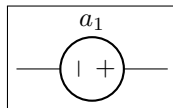

```

1 \begin{circuitikz}[american voltages]
2   \draw (0,0) to[V, v=$a_1$] (2,0);
3 \end{circuitikz}

```

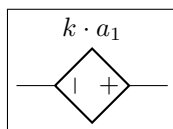

```

1 \begin{circuitikz}[american voltages]
2   \draw (0,0) to[cV=$k\cdot a_1$] (2,0);
3 \end{circuitikz}

```

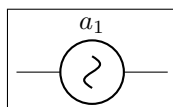

```

1 \begin{circuitikz}[american voltages]
2   \draw (0,0) to[sV=$a_1$] (2,0);
3 \end{circuitikz}

```

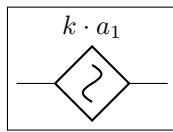

```

1 \begin{circuitikz}[american voltages]
2   \draw (0,0) to[csV= $k \cdot a_1$ ] (2,0);
3 \end{circuitikz}

```

4.6 Integration with siunitx

If the option `siunitx` is active (and *not* in `ConTeXt`), then the following are equivalent:

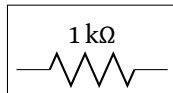

```

1 \begin{circuitikz}
2   \draw (0,0) to[R, l=1<\kilo\ohm>] (2,0);
3 \end{circuitikz}

```

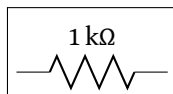

```

1 \begin{circuitikz}
2   \draw (0,0) to[R, l= $\SI{1}{\kilo\ohm}$ ] (2,0);
3 \end{circuitikz}

```

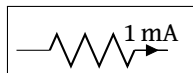

```

1 \begin{circuitikz}
2   \draw (0,0) to[R, i=1<\milli\ampere>] (2,0);
3 \end{circuitikz}

```

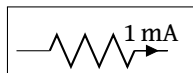

```

1 \begin{circuitikz}
2   \draw (0,0) to[R, i= $\SI{1}{\milli\ampere}$ ] (2,0);
3 \end{circuitikz}

```

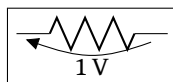

```

1 \begin{circuitikz}
2   \draw (0,0) to[R, v=1<\volt>] (2,0);
3 \end{circuitikz}

```

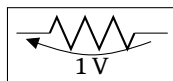

```

1 \begin{circuitikz}
2   \draw (0,0) to[R, v= $\SI{1}{\volt}$ ] (2,0);
3 \end{circuitikz}

```

4.7 Mirroring

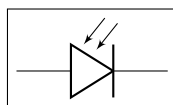

```

1 \begin{circuitikz}
2   \draw (0,0) to[pD] (2,0);
3 \end{circuitikz}

```

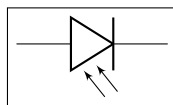

```

1 \begin{circuitikz}
2   \draw (0,0) to[pD, mirror] (2,0);
3 \end{circuitikz}

```

At the moment, placing labels and currents on mirrored bipoles works:

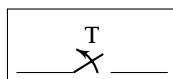

```

1 \begin{circuitikz}
2   \draw (0,0) to[ospst=T] (2,0);
3 \end{circuitikz}

```

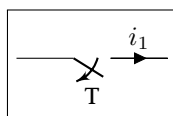

```

1 \begin{circuitikz}
2   \draw (0,0) to[ospst=T, mirror, i= $i_1$ ] (2,0);
3 \end{circuitikz}

```

But voltages don't:

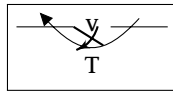

```

1 \begin{circuitikz}
2   \draw (0,0) to[ospst=T, mirror, v=v] (2,0);
3 \end{circuitikz}

```

Sorry about that.

4.8 Putting them together

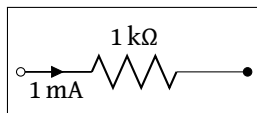

```

1 \begin{circuitikz}
2   \draw (0,0) to[R=1<\kilo\ohm>,
3     i>_ =1<\milli\ampere>, o-^*] (3,0);
4 \end{circuitikz}

```

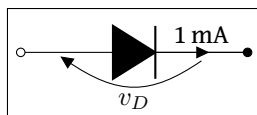

```

1 \begin{circuitikz}
2   \draw (0,0) to[D*, v=$v_D$,
3     i=1<\milli\ampere>, o-^*] (3,0);
4 \end{circuitikz}

```

5 Not only bipoles

Since only bipoles (but see section 5.3) can be placed "along a line", components with more than two terminals are placed as nodes:

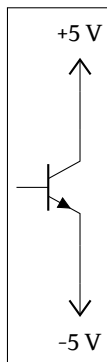

```

1 \begin{circuitikz}
2   \draw (0,0) node[npn](npn) at (0,0) {};
3   \draw (npn.C) ---++(0,0.5) node[vcc]{+5\,\textnormal{V}};
4   \draw (npn.E) ---++(0,-0.5) node[vee]{-5\,\textnormal{V}};
5 \end{circuitikz}

```

5.1 Anchors

In order to allow connections with other components, all components define anchors.

5.1.1 Logical ports

All logical ports, except not, have two inputs and one output. They are called respectively in 1, in 2, out:

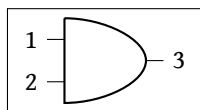

```

1 \begin{circuitikz} \draw
2   (0,0) node[and port] (myand) {}
3   (myand.in 1) node[anchor=east] {1}
4   (myand.in 2) node[anchor=east] {2}
5   (myand.out) node[anchor=west] {3}
6 ;\end{circuitikz}

```

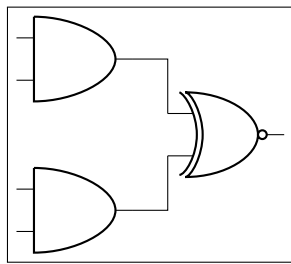

```

1 \begin{circuitikz} \draw
2 (0,2) node[and port] (myand1) {}
3 (0,0) node[and port] (myand2) {}
4 (2,1) node[xnor port] (myxnor) {}
5 (myand1.out) -| (myxnor.in 1)
6 (myand2.out) -| (myxnor.in 2)
7 ;\end{circuitikz}

```

In the case of not, there are only in and out (although for compatibility reasons in 1 is still defined and equal to in):

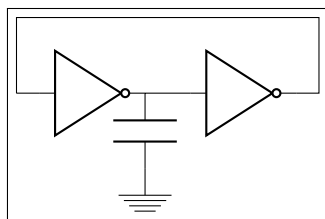

```

1 \begin{circuitikz} \draw
2 (1,0) node[not port] (not1) {}
3 (3,0) node[not port] (not2) {}
4 (0,0) -- (not1.in)
5 (not2.in) -- (not1.out)
6 ++(0,-1) node[ground] {} to[C] (not1.out)
7 (not2.out) -| (4,1) -| (0,0)
8 ;\end{circuitikz}

```

5.1.2 Transistors

For nmos, pmos, nfet, nifgete, nigfetd, pfet, pigfete, and pigfetd transistors one has base, gate, source and drain anchors (which can be abbreviated with B, G, S and D):

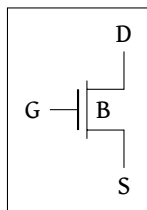

```

1 \begin{circuitikz} \draw
2 (0,0) node[nmos] (mos) {}
3 (mos.base) node[anchor=west] {B}
4 (mos.gate) node[anchor=east] {G}
5 (mos.drain) node[anchor=south] {D}
6 (mos.source) node[anchor=north] {S}
7 ;\end{circuitikz}

```

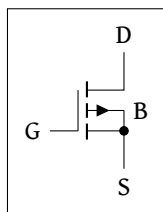

```

1 \begin{circuitikz} \draw
2 (0,0) node[pigfete] (pigfete) {}
3 (pigfete .B) node[anchor=west] {B}
4 (pigfete .G) node[anchor=east] {G}
5 (pigfete .D) node[anchor=south] {D}
6 (pigfete .S) node[anchor=north] {S}
7 ;\end{circuitikz}

```

Similarly njfet and pjfet have gate, source and drain anchors (which can be abbreviated with G, S and D):

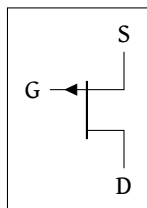

```

1 \begin{circuitikz} \draw
2 (0,0) node[pjfet] (pjfet) {}
3 (pjfet .G) node[anchor=east] {G}
4 (pjfet .D) node[anchor=north] {D}
5 (pjfet .S) node[anchor=south] {S}
6 ;\end{circuitikz}

```

For npn, pnp, nigt, and pigbt transistors the anchors are base, emitter and collector anchors (which can be abbreviated with B, E and C):

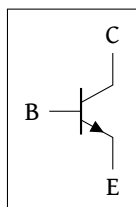

```

1 \begin{circuitikz} \draw
2 (0,0) node[npn] (npn) {}
3 (npn.base) node[anchor=east] {B}
4 (npn.collector) node[anchor=south] {C}
5 (npn.emitter) node[anchor=north] {E}
6 ;\end{circuitikz}

```

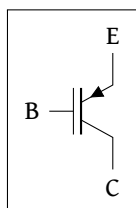

```

1 \begin{circuitikz} \draw
2 (0,0) node[pigbt] (pigbt) {}
3 (pigbt.B) node[anchor=east] {B}
4 (pigbt.C) node[anchor=north] {C}
5 (pigbt.E) node[anchor=south] {E}
6 ;\end{circuitikz}

```

Here is one composite example (please notice that the `xscale=-1` style would also reflect the label of the transistors, so here a new node is added and its text is used, instead of that of `pnp1`):

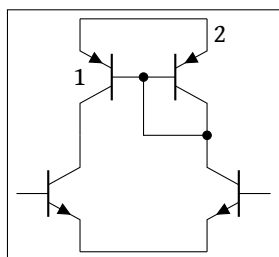

```

1 \begin{circuitikz} \draw
2 (0,0) node[pnp] (pnp2) {2}
3 (pnp2.B) node[pnp, xscale=-1, anchor=B] (pnp1) {}
4 (pnp1) node {1}
5 (pnp1.C) node[npn, anchor=C] (nnp1) {}
6 (pnp2.C) node[npn, xscale=-1, anchor=C] (nnp2) {}
7 (pnp1.E) -- (pnp2.E) (nnp1.E) -- (nnp2.E)
8 (pnp1.B) node[circ] {} |-(pnp2.C) node[circ] {}
9 ;\end{circuitikz}

```

Similarly, transistors and other components can be reflected vertically:

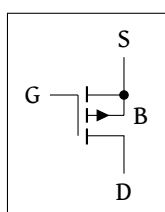

```

1 \begin{circuitikz} \draw
2 (0,0) node[pigfete, yscale=-1] (pigfete) {}
3 (pigfete.B) node[anchor=west] {B}
4 (pigfete.G) node[anchor=east] {G}
5 (pigfete.D) node[anchor=north] {D}
6 (pigfete.S) node[anchor=south] {S}
7 ;\end{circuitikz}

```

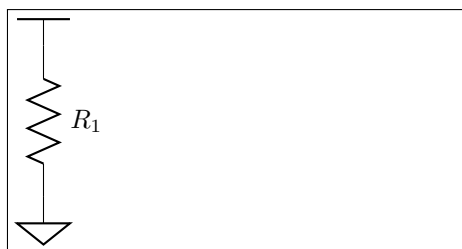

```

1 \begin{circuitikz}
2 \draw (0,2)
3 node[rground, yscale=-1] {}
4 to[R=$R_1$] (0,0)
5 node[sground] {};
6 \end{circuitikz}

```

5.1.3 Other tripoles

When inserting a thyristor, a triac or a potentiometer, one needs to refer to the third node—gate (gate or G) for the former two; wiper (wiper or W) for the latter one. This is done by giving a name to the bipole:

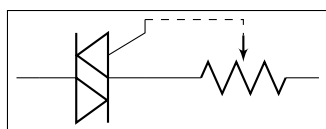

```

1 \begin{circuitikz} \draw
2 (0,0) to[Tr, n=TRI] (2,0)
3 to[pR, n=POT] (4,0);
4 \draw[dashed] (TRI.G) -| (POT.wiper)
5 ;\end{circuitikz}

```

As for the switches:

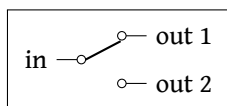

```

1 \begin{circuitikz} \draw
2 (0,0) node[spdt] (Sw) {}
3 (Sw.in) node[left] {in}
4 (Sw.out 1) node[right] {out 1}
5 (Sw.out 2) node[right] {out 2}
6 ;\end{circuitikz}

```

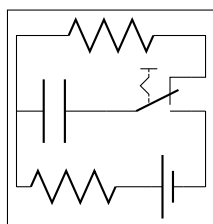

```

1 \begin{circuitikz} \draw
2 (0,0) to[C] (1,0) to[toggle switch , n=Sw] (2.5,0)
3 -- (2.5,-1) to[battery1] (1.5,-1) to[R] (0,-1) -| (0,0)
4 (Sw.out 2) -| (2.5, 1) to[R] (0,1) -- (0,0)
5 ;\end{circuitikz}

```

And the mixer:

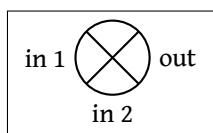

```

1 \begin{circuitikz} \draw
2 (0,0) node[mixer] (mix) {}
3 (mix.in 1) node[left] {in 1}
4 (mix.in 2) node[below] {in 2}
5 (mix.out) node[right] {out}
6 ;\end{circuitikz}

```

5.1.4 Operational amplifier

The op amp defines the inverting input (-), the non-inverting input (+) and the output (out) anchors:

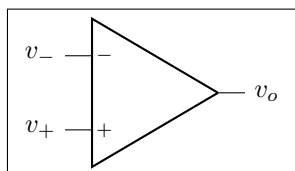

```

1 \begin{circuitikz} \draw
2 (0,0) node[op amp] (opamp) {}
3 (opamp.+) node[left] {$v_+$}
4 (opamp.-) node[left] {$v_-}$}
5 (opamp.out) node[right] {$v_o$}
6 ;\end{circuitikz}

```

There are also two more anchors defined, up and down, for the power supplies:

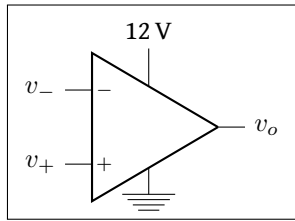

```

1 \begin{circuitikz} \draw
2 (0,0) node[op amp] (opamp) {}
3 (opamp.+) node[left] {$v_+$}
4 (opamp.-) node[left] {$v_-$}
5 (opamp.out) node[right] {$v_o$}
6 (opamp.down) node[ground] {}
7 (opamp.up) ++ (0,.5) node[above] {\SI{12}{\ volt}}
8 -- (opamp.up)
9 ;\end{circuitikz}

```

The fully differential op amp defines two outputs:

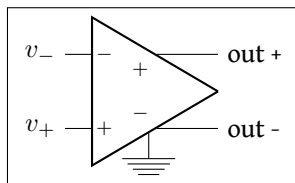

```

1 \begin{circuitikz} \draw
2 (0,0) node[fd op amp] (opamp) {}
3 (opamp.+) node[left] {$v_+$}
4 (opamp.-) node[left] {$v_-$}
5 (opamp.out +) node[right] {out +}
6 (opamp.out -) node[right] {out -}
7 (opamp.down) node[ground] {}
8 ;\end{circuitikz}

```

The circulator defined ports 1, 2 and 3:

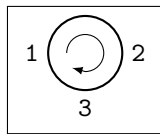

```

1
2
3
4
5
6
7
\begin{circuitikz} \draw
(0,0) node[circulator] (c) {}
(c.1) node[left] {\texttt{1}}
(c.2) node[right] {\texttt{2}}
(c.3) node[below] {\texttt{3}}
;
\end{circuitikz}

```

The Wilkinson divider has:

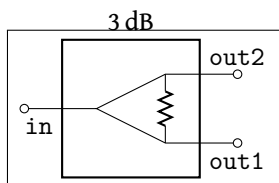

```

1
2
3
4
5
6
7
8
9
10
\begin{circuitikz} \draw
(0,0) node[wilkinson] (w) {\SI{3}{dB}}
(w.in) to[short,-o] ++(-0.5,0)
(w.out1) to[short,-o] ++(0.5,0)
(w.out2) to[short,-o] ++(0.5,0)
(w.in) node[below left] {\texttt{in}}
(w.out1) node[below right] {\texttt{out1}}
(w.out2) node[above right] {\texttt{out2}}
;
\end{circuitikz}

```

5.1.5 Double bipoles

All the (few, actually) double bipoles/quadrupoles have the four anchors, two for each port. The first port, to the left, is port A, having the anchors A1 (up) and A2 (down); same for port B. They also expose the base anchor, for labelling:

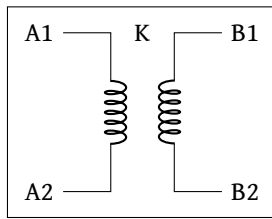

```

1 \begin{circuitikz} \draw
2   (0,0) node[transformer] (T) {}
3   (T.A1) node[anchor=east] {A1}
4   (T.A2) node[anchor=east] {A2}
5   (T.B1) node[anchor=west] {B1}
6   (T.B2) node[anchor=west] {B2}
7   (T.base) node{K}
8 ;\end{circuitikz}

```

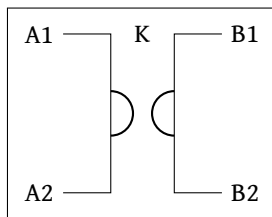

```

1 \begin{circuitikz} \draw
2   (0,0) node[gyrator] (G) {}
3   (G.A1) node[anchor=east] {A1}
4   (G.A2) node[anchor=east] {A2}
5   (G.B1) node[anchor=west] {B1}
6   (G.B2) node[anchor=west] {B2}
7   (G.base) node{K}
8 ;\end{circuitikz}

```

However:

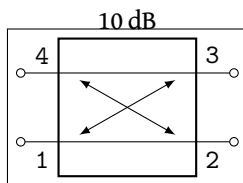

```

1 \begin{circuitikz} \draw
2   (0,0) node[coupler] (c) {\SI{10}{dB}}
3   (c.1) to[short,-o] ++(-0.5,0)
4   (c.2) to[short,-o] ++(0.5,0)
5   (c.3) to[short,-o] ++(0.5,0)
6   (c.4) to[short,-o] ++(-0.5,0)
7   (c.1) node[below left] {\texttt {1}}
8   (c.2) node[below right] {\texttt {2}}
9   (c.3) node[above right] {\texttt {3}}
10  (c.4) node[above left] {\texttt {4}}
11 ;
12 \end{circuitikz}

```

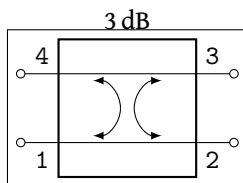

```

1 \begin{circuitikz} \draw
2   (0,0) node[coupler2] (c) {\SI{3}{dB}}
3   (c.1) to[short,-o] ++(-0.5,0)
4   (c.2) to[short,-o] ++(0.5,0)
5   (c.3) to[short,-o] ++(0.5,0)
6   (c.4) to[short,-o] ++(-0.5,0)
7   (c.1) node[below left] {\texttt {1}}
8   (c.2) node[below right] {\texttt {2}}
9   (c.3) node[above right] {\texttt {3}}
10  (c.4) node[above left] {\texttt {4}}
11 ;
12 \end{circuitikz}

```

5.2 Input arrows

two ports

The new two ports all have a defined direction. If one needs opposite direction, just place them from right to left. With the option > a input arrow is drawn:

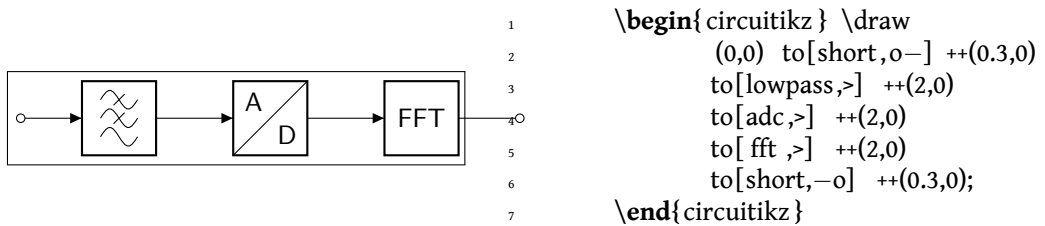

multi ports

Since inputs and outputs can vary, input arrows can be placed as nodes:

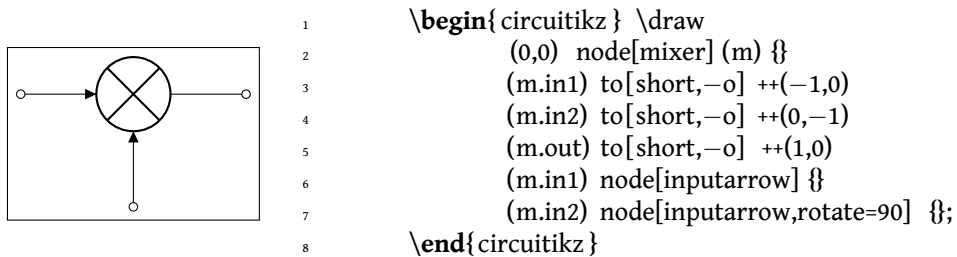

5.3 Transistor paths

For syntactical convenience transistors can be placed using the normal path notation used for bipoles. The transistor type can be specified by simply adding a “T” (for transistor) in front of the node name of the transistor. It will be placed with the base/gate orthogonal to the direction of the path:

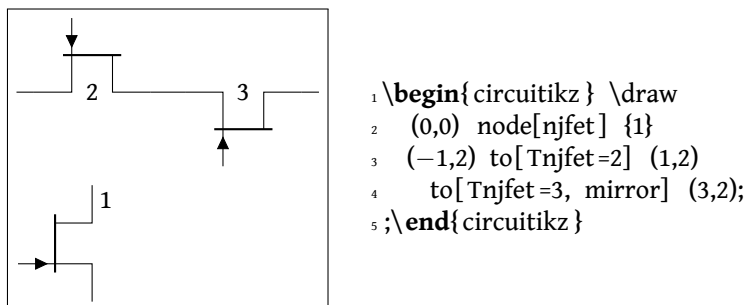

Access to the gate and/or base nodes can be gained by naming the transistors with the n or name path style:

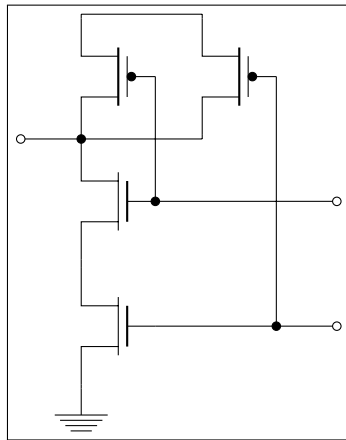

```

1 \begin{circuitikz} \draw[yscale=1.1, xscale=.8]
2 (2,4.5) -- (0,4.5) to[Tpmos, n=p1] (0,3)
3 to[Tnmos, n=n1] (0,1.5)
4 to[Tnmos, n=n2] (0,0) node[ground] {}
5 (2,4.5) to[Tpmos, n=p2] (2,3) to[short, -*] (0,3)
6 (p1.G) -- (n1.G) to[short, *-o] ($(n1.G)+(3,0)$)
7 (n2.G) ++(2,0) node[circ] {} -| (p2.G)
8 (n2.G) to[short, -o] ($(n2.G)+(3,0)$)
9 (0,3) to[short, -o] (-1,3)
10 \end{circuitikz}

```

The name property is available also for bipoles, although this is useful mostly for triac, potentiometer and thyristor (see 3.3.5).

6 Customization

6.1 Parameters

Pretty much all CircuitikZ relies heavily on pgfkeys for value handling and configuration. Indeed, at the beginning of `circuitikz.sty` a series of key definitions can be found that modify all the graphical characteristics of the package.

All can be varied using the `\ctikzset` command, anywhere in the code.

Shape of the components (on a per-component-class basis)

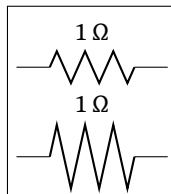

```

1 \tikz \draw (0,0) to[R=1<\ohm>] (2,0); \par
2 \ctikzset {bipoles/resistor/height=.6}
3 \tikz \draw (0,0) to[R=1<\ohm>] (2,0);

```

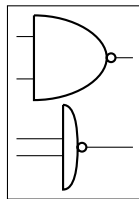

```

1 \tikz \draw (0,0) node[nand port] {}; \par
2 \ctikzset {tripoles/american nand port/input height=.2}
3 \ctikzset {tripoles/american nand port/port width=.2}
4 \tikz \draw (0,0) node[nand port] {};

```

Thickness of the lines (globally)

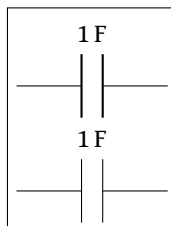

```

1 \tikz \draw (0,0) to[C=1<\farad>] (2,0); \par
2 \ctikzset {bipoles/thickness=1}
3 \tikz \draw (0,0) to[C=1<\farad>] (2,0);

```

Global properties Of voltage and current

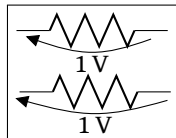

```

1 \tikz \draw (0,0) to[R, v=1<\volt>] (2,0); \par
2 \ctikzset {voltage/distance from node=.1}
3 \tikz \draw (0,0) to[R, v=1<\volt>] (2,0);

```

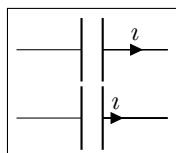

```

1 \tikz \draw (0,0) to[C, i=\imath] (2,0); \par
2 \ctikzset {current/distance = .2}
3 \tikz \draw (0,0) to[C, i=\imath] (2,0);

```

However, you can override the properties `voltage/distance from node`⁸, `voltage/bump b`⁹ and `voltage/european label distance`¹⁰ on a per-component basis, in order to fine-tune the voltages:

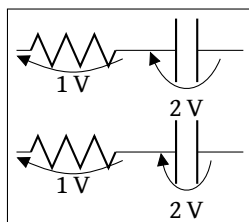

```

1 \tikz \draw (0,0) to[R, v=1<\volt>] (1.5,0)
2     to[C, v=2<\volt>] (3,0); \par
3 \ctikzset {bipoles/capacitor/voltage/%
4     distance from node/. initial =.7}
5 \tikz \draw (0,0) to[R, v=1<\volt>] (1.5,0)
6     to[C, v=2<\volt>] (3,0); \par

```

Admittedly, not all graphical properties have understandable names, but for the time it will have to do:

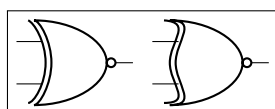

```

1 \tikz \draw (0,0) node[xnor port] {};
2 \ctikzset {tripoles/american xnor port/aaa=.2}
3 \ctikzset {tripoles/american xnor port/bbb=.6}
4 \tikz \draw (0,0) node[xnor port] {};

```

6.2 Components size

Perhaps the most important parameter is `\circuitikzbasekey/bipoles/length`, which can be interpreted as the length of a resistor (including reasonable connections): all other lengths are relative to this value. For instance:

⁸That is, how distant from the initial and final points of the path the arrow starts and ends.

⁹Controlling how high the bump of the arrow is — how curved it is.

¹⁰Controlling how distant from the bipole the voltage label will be.

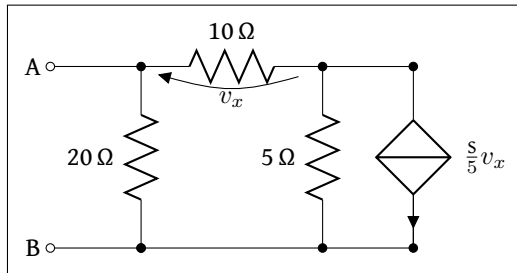

```

1 \ctikzset {bipoles/length=1.4cm}
2 \begin{circuitikz} [scale=1.2] \draw
3   (0,0) node[anchor=east] {B}
4     to[short, o-*] (1,0)
5     to[R=20<\ohm>, *-] (1,2)
6     to[R=10<\ohm>, v=$v_x$] (3,2) -- (4,2)
7     to[ci=$\frac{5}{5} v_x$, *-] (4,0) -- (3,0)
8     to[R=5<\ohm>, *-] (3,2)
9   (3,0) -- (1,0)
10  (1,2) to[short, -o] (0,2) node[anchor=east]{A}
11 ;\end{circuitikz}

```

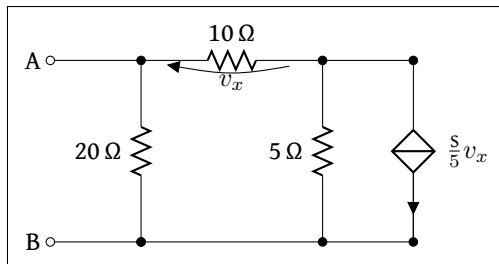

```

1 \ctikzset {bipoles/length=.8cm}
2 \begin{circuitikz} [scale=1.2] \draw
3   (0,0) node[anchor=east] {B}
4     to[short, o-*] (1,0)
5     to[R=20<\ohm>, *-] (1,2)
6     to[R=10<\ohm>, v=$v_x$] (3,2) -- (4,2)
7     to[ci=$\frac{5}{5} v_x$, *-] (4,0) -- (3,0)
8     to[R=5<\ohm>, *-] (3,2)
9   (3,0) -- (1,0)
10  (1,2) to[short, -o] (0,2) node[anchor=east]{A}
11 ;\end{circuitikz}

```

6.3 Colors

The color of the components is stored in the key `\circuitikzbasekey/color`. `CircuitikZ` tries to follow the color set in `TikZ`, although sometimes it fails. If you change color in the picture, please do not use just the color name as a style, like `[red]`, but rather assign the style `[color=red]`.

Compare for instance

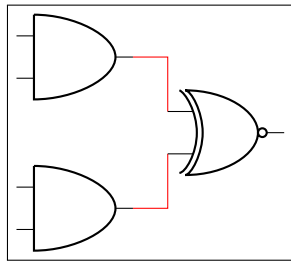

```

1 \begin{circuitikz} \draw[red]
2 (0,2) node[and port] (myand1) {}
3 (0,0) node[and port] (myand2) {}
4 (2,1) node[xnor port] (myxnor) {}
5 (myand1.out) -| (myxnor.in 1)
6 (myand2.out) -| (myxnor.in 2)
7 ;\end{circuitikz}

```

and

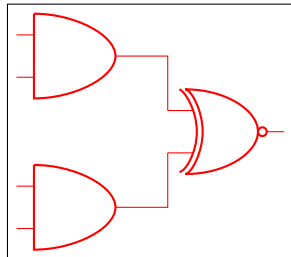

```

1 \begin{circuitikz} \draw[color=red]
2 (0,2) node[and port] (myand1) {}
3 (0,0) node[and port] (myand2) {}
4 (2,1) node[xnor port] (myxnor) {}
5 (myand1.out) -| (myxnor.in 1)
6 (myand2.out) -| (myxnor.in 2)
7 ;\end{circuitikz}

```

One can of course change the color *in medias res*:

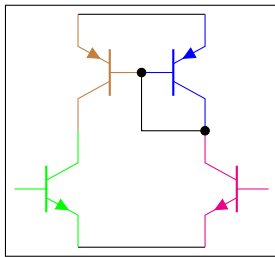

```

1 \begin{circuitikz} \draw
2 (0,0) node[PNP, color=blue] (pnp2) {}
3 (pnp2.B) node[PNP, xscale=-1, anchor=B, color=brown] (pnp1) {}
4 (pnp1.C) node[NPN, anchor=C, color=green] (npn1) {}
5 (pnp2.C) node[NPN, xscale=-1, anchor=C, color=magenta] (npn2) {}
6 (pnp1.E) -- (pnp2.E) (npn1.E) -- (npn2.E)
7 (pnp1.B) node[circ] {} |- (pnp2.C) node[circ] {}
8 ;\end{circuitikz}

```

The all-in-one stream of bipoles poses some challenges, as only the actual body of the bipole, and not the connecting lines, will be rendered in the specified color. Also, please notice the curly braces around the to:

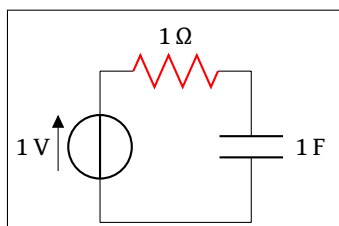

```

1 \begin{circuitikz} \draw
2 (0,0) to[V=1<\volt>] (0,2)
3 { to[R=1<\ohm>, color=red] (2,2) }
4 to[C=1<\farad>] (2,0) -- (0,0)
5 ;\end{circuitikz}

```

Which, for some bipoles, can be frustrating:

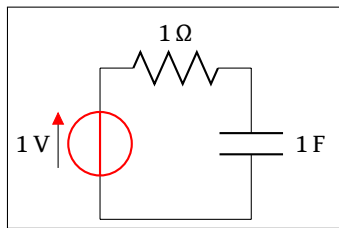

```

1 \begin{circuitikz} \draw
2   (0,0){ to[V=1<\volt>, color=red] (0,2) }
3     to[R=1<\ohm>] (2,2)
4     to[C=1<\farad>] (2,0) -- (0,0)
5 ;\end{circuitikz}

```

The only way out is to specify different paths:

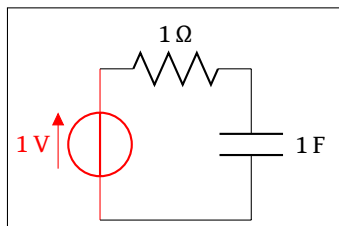

```

1 \begin{circuitikz} \draw[color=red]
2   (0,0) to[V=1<\volt>, color=red] (0,2);
3   \draw (0,2) to[R=1<\ohm>] (2,2)
4     to[C=1<\farad>] (2,0) -- (0,0)
5 ;\end{circuitikz}

```

And yes: this is a bug and *not* a feature...

7 FAQ

Q: When using `\tikzexternalize` I get the following error:

! Emergency stop.

A: The TikZ manual states:

Furthermore, the library assumes that all \TeX pictures are ended with `\end{tikzpicture}`.

Just substitute every occurrence of the environment `circuitikz` with `tikzpicture`. They are actually pretty much the same.

Q: How do I draw the voltage between two nodes?

A: Between any two nodes there is an open circuit!

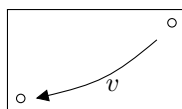

```

1 \begin{circuitikz} \draw
2   node[ocirc] (A) at (0,0) {}
3   node[ocirc] (B) at (2,1) {}
4   (A) to[open, v=$v$] (B)
5 ;\end{circuitikz}

```

Q: I cannot write `to[R = $R_1=12V$]` nor `to[ospst = open, 3s]`: I get errors.

A: It is a limitation of the TikZ parser. Use `to[R = $R_1{=}12V$]` and `to[ospst = open{,} 3s]` instead.

8 Examples

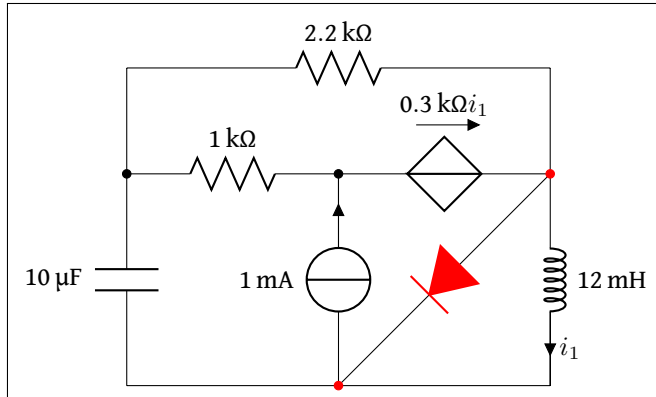

```

1 \begin{circuitikz} [ scale =1.4] \draw
2   (0,0) to[C, l=10<\micro\farad>] (0,2) --- (0,3)
3     to[R, l=2.2<\kilo\ohm>] (4,3) --- (4,2)
4     to[L, l=12<\milli\henry>, i=$i_1$] (4,0) --- (0,0)
5   (4,2) { to[D*, *-*, color=red] (2,0) }
6   (0,2) to[R, l=1<\kilo\ohm>, *-] (2,2)
7     to[cV, v=$\SI{.3}{\kilo\ohm} i_1$] (4,2)
8   (2,0) to[I, i=1<\milli\ampere>, -*] (2,2)
9 ;\end{circuitikz}

```

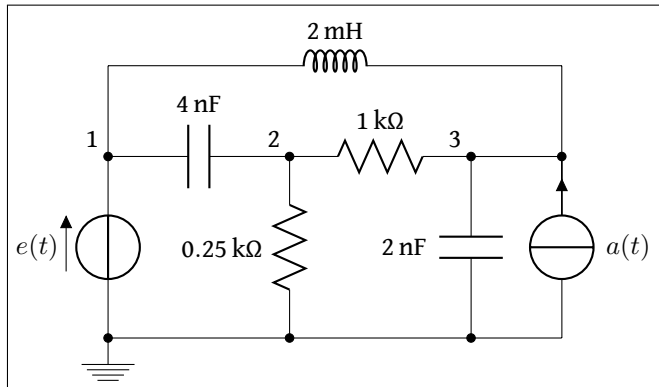

```

1 \begin{ circuitikz }[ scale =1.2]\draw
2   (0,0) node[ground] {}
3     to[V=$e(t)$, *-] (0,2) to[C=4<\nano\farad>] (2,2)
4     to[R, l=.25<\kilo\ohm>, *-] (2,0)
5   (2,2) to[R=1<\kilo\ohm>] (4,2)
6     to[C, l=2<\nano\farad>, *-] (4,0)
7   (5,0) to[I, i=$a(t)$, -*] (5,2) -- (4,2)
8   (0,0) -- (5,0)
9   (0,2) -- (0,3) to[L, l=2<\milli\henry>] (5,3) -- (5,2)
10
11  {[anchor=south east] (0,2) node {1} (2,2) node {2} (4,2) node {3}}
12 ;\end{ circuitikz }

```

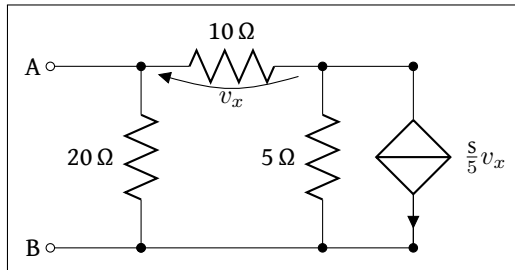

```

1 \begin{ circuitikz }[ scale =1.2]\draw
2   (0,0) node[anchor=east] {B}
3     to[short, o-*] (1,0)
4     to[R=20<\ohm>, *-] (1,2)
5     to[R=10<\ohm>, v=$v_x$] (3,2) -- (4,2)
6     to[ci=$\frac{\siemens}{5} v_x$, *-] (4,0) -- (3,0)
7     to[R=5<\ohm>, *-] (3,2)
8   (3,0) -- (1,0)
9   (1,2) to[short, -o] (0,2) node[anchor=east]{A}
10 ;\end{ circuitikz }

```

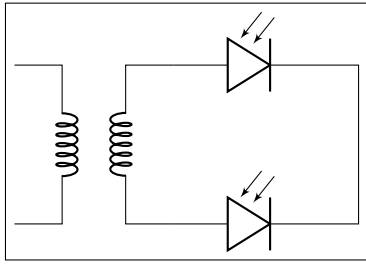

```

1 \begin{circuitikz} [ scale=1] \draw
2     (0,0) node[transformer] (T) {}
3     (T.B2) to [pD] ($(T.B 2)+(2,0)$) -| (3.5, -1)
4     (T.B1) to [pD] ($(T.B 1)+(2,0)$) -| (3.5, -1)
5 ;\end{circuitikz}

```

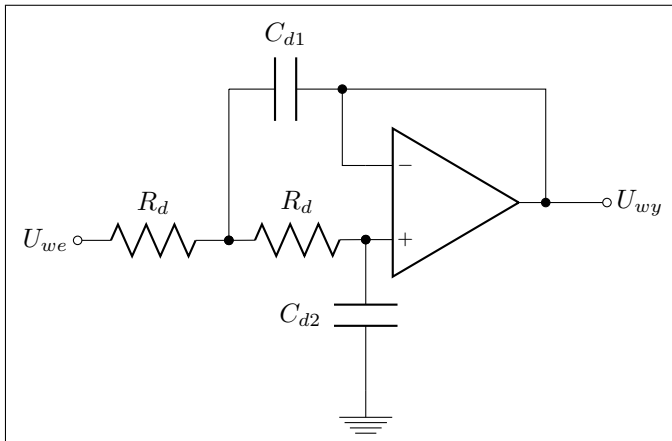

```

1 \begin{circuitikz} [ scale=1] \draw
2     (5,.5) node [op amp] (opamp) {}
3     (0,0) node [ left ] {$U_{we}$} to [R, l=$R_d$, o-] (2,0)
4     to [R, l=$R_d$, *-] (opamp.+)
5     to [C, l=$C_{d2}$, *-] ($(opamp.+) + (0,-2)$) node [ground] {}
6     (opamp.out) -| (3.5,2) to [C, l=$C_{d1}$, *-] (2,2) to [short] (2,0)
7     (opamp.-) -| (3.5,2)
8     (opamp.out) to [short, *-o] (7,.5) node [right] {$U_{wy}$}
9 ;\end{circuitikz}

```

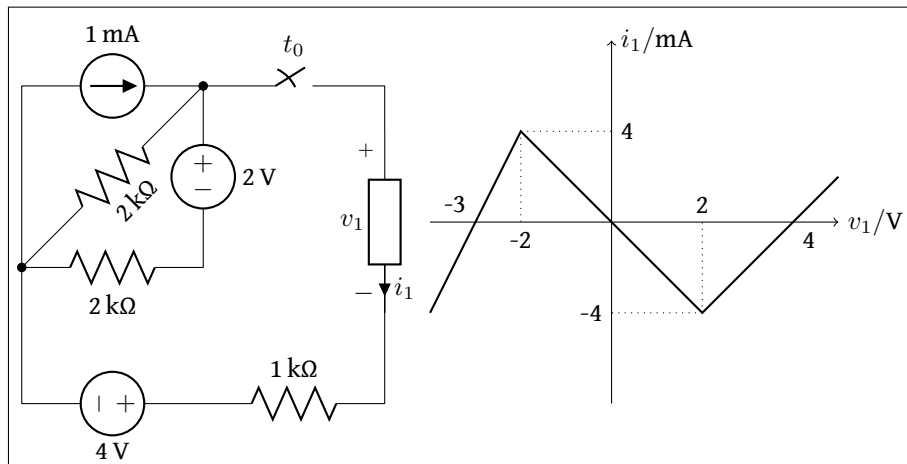

```

1 \begin{circuitikz}[ scale =1.2, american]\draw
2   (0,2) to[I=1<\milli\ampere>] (2,2)
3     to[R, l_2=2<\kilo\ohm>,*-] (0,0)
4     to[R, l_2=2<\kilo\ohm>] (2,0)
5     to[V, v_2=2<\volt>] (2,2)
6     to[csfst, l=$t_0$] (4,2) -- (4,1.5)
7     to [generic, i=$i_1$, v=$v_1$] (4,-.5) -- (4,-1.5)
8   (0,2) -- (0,-1.5) to[V, v_4=4<\volt>] (2,-1.5)
9     to [R, l=1<\kilo\ohm>] (4,-1.5);
10
11 \begin{scope}[ xshift =6.5cm, yshift =.5cm]
12   \draw [->] (-2,0) -- (2.5,0) node[anchor=west] {$v_1/\text{V}$};
13   \draw [->] (0,-2) -- (0,2) node[anchor=west] {$i_1/\text{mA}$};
14   \draw (-1,0) node[anchor=north] {-2} (1,0) node[anchor=south] {2}
15     (0,1) node[anchor=west] {4} (0,-1) node[anchor=east] {-4}
16     (2,0) node[anchor=north west] {4}
17     (-1.5,0) node[anchor=south east] {-3};
18   \draw [thick] (-2,-1) -- (-1,1) -- (1,-1) -- (2,0) -- (2.5,.5);
19   \draw [dotted] (-1,1) -- (-1,0) (1,-1) -- (1,0)
20     (-1,1) -- (0,1) (1,-1) -- (0,-1);
21 \end{scope}
22 \end{circuitikz}

```

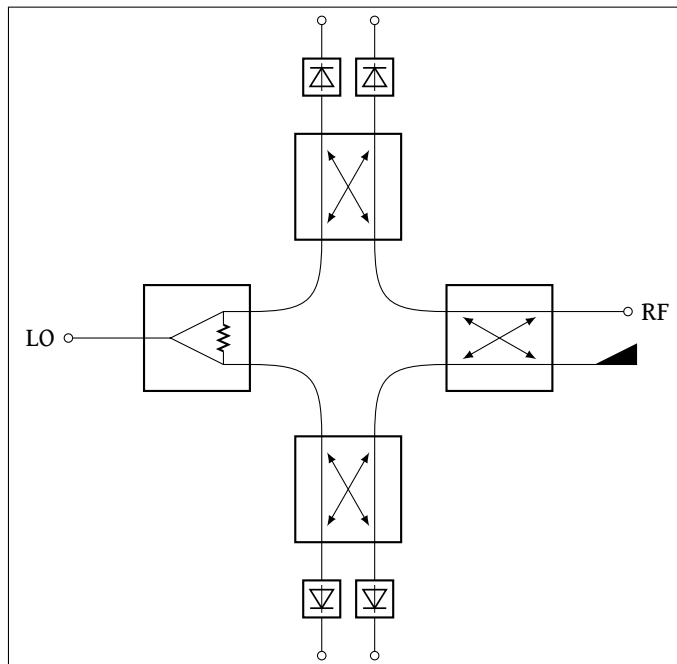

```

1      \begin{circuitikz} [ scale=1]
2          \ctikzset {bipoles/detector/width=.35}
3          \ctikzset {quadpoles/coupler/width=1}
4          \ctikzset {quadpoles/coupler/height=1}
5          \ctikzset {tripoles/wilkinson/width=1}
6          \ctikzset {tripoles/wilkinson/height=1}
7          %\draw[help lines , red , thin , dotted] (0,-5) grid (5,5);
8          \draw
9          (-2,0) node[wilkinson](w1){
10             (2,0) node[coupler] (c1) {}
11             (0,2) node[coupler,rotate=90] (c2) {}
12             (0,-2) node[coupler,rotate=90] (c3) {}
13             (w1.out1) .. controls ++(0.8,0) and ++(0,0.8) .. (c3.3)
14             (w1.out2) .. controls ++(0.8,0) and ++(0,-0.8) .. (c2.4)
15             (c1.1) .. controls ++(-0.8,0) and ++(0,0.8) .. (c3.2)
16             (c1.4) .. controls ++(-0.8,0) and ++(0,-0.8) .. (c2.1)
17             (w1.in) to[short,-o] ++(-1,0)
18             (w1.in) node[left=30] {LO}
19             (c1.2) node[match,yscale=1] {}
20             (c1.3) to[short,-o] ++(1,0)
21             (c1.3) node[right=30] {RF}
22             (c2.3) to[detector,-o] ++(0,1.5)
23             (c2.2) to[detector,-o] ++(0,1.5)
24             (c3.1) to[detector,-o] ++(0,-1.5)
25             (c3.4) to[detector,-o] ++(0,-1.5)
26             ;
27      \end{circuitikz}

```

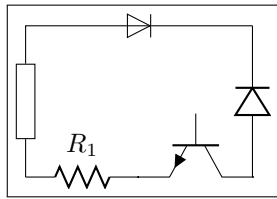

```

1 \documentclass{standalone}
2
3 \usepackage{tikz}
4 \usetikzlibrary { circuits .ee.IEC}
5 \usetikzlibrary { positioning}
6
7 \usepackage[compatibility]{ circuitikz }
8 \ctikzset { bipoles/length=.9cm}
9
10 \begin{document}
11 \begin{tikzpicture} [ circuit ee IEC]
12 \draw (0,0) to [ resistor = {name=R}] (0,2)
13 to [ diode = {name=D}] (3,2);
14 \draw (0,0) to [*R=$R_1$] (1.5,0) to [*Tnpn] (3,0)
15 to [*D ](3,2);
16 \end{tikzpicture}
17 \end{document}

```

9 Revision history

version 0.4 (in progress)

1. minor improvements to documentation
2. comply with TDS
3. merge high frequency symbols by Stefan Erhardt
4. added switch (not opening nor closing)
5. added added solder dot in some transistors
6. improved ConTeXt compatibility

version 0.3.1

1. typo in documentation
2. fixed an error in the angle computation in voltage and current routines
3. fixed problem with label size when scaling a tikz picture
4. added gas filled surge arrester
5. added compatibility option to work with Tikz's own circuit library

version 0.3.0 (20121229)

1. fixed gate node for a few transistors
2. added mixer
3. added fully differential op amp (by Kristofer M. Monisit)

4. now general settings for the drawing of voltage can be overridden for specific components
5. made arrows more homogeneous (either the current/voltage one, or latex' by pgf)
6. added the single battery cell
7. added fuse and asymmetric fuse
8. added toggle switch
9. added varistor, photoresistor, thermocouple, push button
10. added thermistor, thermistor ptc, thermistor ptc
11. fixed misalignment of voltage label in vertical bipoles with names
12. added isfet
13. added noiseless, protective, chassis, signal and reference grounds (Luigi Luigi «Liverpool»)

version 0.2.4 (20110911).

1. added square voltage source (contributed by Alistair Kwan)
2. added buffer and plain amplifier (contributed by Danilo Piazzalunga)
3. added squid and barrier (contributed by Cor Molenaar)
4. added antenna and transmission line symbols contributed by Leonardo Azzinnari
5. added the changeover switch spdt (suggestion of Fabio Maria Antoniali)
6. rename of context.tex and context.pdf (thanks to Karl Berry)
7. updated the email address
8. in documentation, fixed wrong (non-standard) labelling of the axis in an example (thanks to prof. Claudio Beccaria)
9. fixed scaling inconsistencies in quadrupoles
10. fixed division by zero error on certain vertical paths
11. introduced options straightlabels, rotatlabels, smartlabels

version 0.2.3 (20091118).

1. fixed compatibility problem with label option from tikz
2. Fixed resizing problem for shape ground
3. Variable capacitor
4. polarized capacitor
5. ConT_EXt support (read the manual!)
6. nfet, nifete, nigfetd, pfet, pigfete, pigfetd (contribution of Clemens Helfmeier and Theodor Borsche)
7. njfet, pjfet (contribution of Danilo Piazzalunga)
8. pigbt, nigbt
9. *backward incompatibility* potentiometer is now the standard resistor-with-arrow-in-the-middle; the old potentiometer is now known as variable resistor (or vR), similarly to variable inductor and variable capacitor

10. triac, thyristor, memristor
11. new property "name" for bipoles
12. fixed voltage problem for batteries in american voltage mode
13. european logic gates
14. *backward incompatibility* new american standard inductor. Old american inductor now called "cute inductor"
15. *backward incompatibility* transformer now linked with the chosen type of inductor, and version with core, too. Similarly for variable inductor
16. *backward incompatibility* styles for selecting shape variants now end are in the plural to avoid conflict with paths
17. new placing option for some tripoles (mostly transistors)
18. mirror path style

version 0.2.2 (20090520).

1. Added the shape for lamps.
2. Added options `europeanresistor`, `europeaninductor`, `americanresistor` and `americaninductor`, with corresponding styles.
3. **Fixed:** error in transistor arrow positioning and direction under negative `xscale` and `yscale`.

version 0.2.1 (20090503).

1. Op-amps added.
2. Added options `arrowmos` and `noarrowmos`.

version 0.2 First public release on CTAN (20090417).

1. **Backward incompatibility:** labels ending with `:angle` are not parsed for positioning anymore.
2. Full use of TikZ keyval features.
3. White background is not filled anymore: now the network can be drawn on a background picture as well.
4. Several new components added (logical ports, transistors, double bipoles, ...).
5. Color support.
6. Integration with `siunitx`.
7. Voltage, american style.
8. Better code, perhaps. General cleanup at the very least.

version 0.1 First public release (2007).

Index of the components

adc, 18
afuse, 11
ageneric, 9
american and port, 26
american controlled current source, 20
american controlled voltage source, 20
american current source, 12
american gas filled surge arrester, 14
american inductor, *see* L
american nand port, 27
american nor port, 27
american not port, 26
american or port, 26
american potentiometer, *see* pR
american resistor, *see* R
american voltage source, 12
american xnor port, 27
american xor port, 27
ammeter, 9
amp, 18
antenna, 8
asymmetric fuse, *see* afuse

bandpass, 17
barrier, 14
battery, 12
battery1, 12
buffer, 29

C, *see* capacitor
capacitor, 15
cground, 7
circ, 29
circulator, 24
courcesin, *see* controlled sinusoidal current source
closing switch, 17
controlled icsourcesin, *see* controlled sinusoidal current source
controlled sinusoidal current source, 20
controlled sinusoidal voltage source, 20
controlled vsourcesin, *see* controlled sinusoidal voltage source
coupler, 26

coupler2, 26
csI, *see* controlled sinusoidal current source
cspst, *see* closing switch
csV, *see* controlled sinusoidal voltage source
currarrow, 29
cute inductor, *see* L
cvsourcesin, *see* controlled sinusoidal voltage source

D*, *see* full diode
dac, 18
dcisource, 17
dcvsource, 17
detector, 19
Do, *see* empty diode
dsp, 18

empty diode, 13
empty led, 13
empty photodiode, 13
empty Schottky diode, 13
empty tunnel diode, 13
empty varcap, 13
empty Zener diode, 13
esource, 16
european and port, 27
european controlled current source, 20
european controlled voltage source, 19
european current source, 12
european gas filled surge arrester, 14
european inductor, *see* L
european nand port, 27
european nor port, 27
european not port, 27
european or port, 27
european potentiometer, *see* pR
european resistor, *see* R
european variable resistor, *see* vR
european voltage source, 12
european xnor port, 28
european xor port, 28

fd op amp, 28
fft, 18

full diode, 13
 full led, 14
 full photodiode, 14
 full Schottky diode, 13
 full tunnel diode, 14
 full varcap, 14
 full Zener diode, 14
 fullgeneric, 10
 fuse, 11

 generic, 9
 gm amp, 28
 ground, 7
 gyrator, 26

 highpass, 18

 isfet, 23
 isourcesin, *see* sinusoidal current source

 L, 15, 16
 lamp, 9
 leD*, *see* full led
 leDo, *see* empty led
 lowpass, 18

 match, 8
 memristor, 10
 mixer, 24
 Mr, *see* memristor

 nfet, 22
 nground, 7
 nigbt, 21
 nigfefd, 22
 nigfete, 22
 nigfetebulk, 22
 njfet, 23
 nmos, 21
 npn, 21

 ocirc, 29
 ohmmeter, 9
 op amp, 28
 open, 9
 opening switch, 17
 oscillator, 8
 ospst, *see* opening switch

 pC, *see* polar capacitor

 pD*, *see* full photodiode
 pDo, *see* empty photodiode
 pfet, 22
 pground, 7
 phaseshifter, 19
 photoresistor, *see* phR
 phR, 11
 piattenuator, 19
 pigbt, 21
 pigfefd, 23
 pigfete, 23
 pigfetebulk, 23
 pjfet, 23
 plain amp, 29
 pmos, 21, 22
 pnp, 21
 polar capacitor, 15
 pR, 10
 push button, 17

 R, 10
 rground, 7
 rxantenna, 8

 sD*, *see* full Schottky diode
 sDo, *see* empty Schottky diode
 sground, 7
 short, 9
 sl, *see* sinusoidal current source
 sinusoidal current source, 16
 sinusoidal voltage source, 16
 spdt, 24
 spst, *see* switch
 square voltage source, 16
 squid, 14
 sqV, *see* square voltage source
 sV, *see* sinusoidal voltage source
 switch, 17

 tattenuator, 19
 tD*, *see* full tunnel diode
 tDo, *see* empty tunnel diode
 tfullgeneric, 10
 tgeneric, 9
 thermistor, *see* thR
 thermistor ntc, *see* thRn
 thermistor ptc, *see* thRp
 thermocouple, 11
 thR, 11
 thRn, 11

thRp, 11
thyristor, 24
TL, 16
tline, *see* TL
tlinestub, 8
toggle switch, 24
Tr, *see* triac
transformer, 25
transformer core, 25
transmission line, *see* TL
triac, 24
twoport, 17
txantenna, 8
Ty, *see* thyristor

vamp, 18
variable american inductor, *see* vL
variable american resistor, *see* vR
variable capacitor, 15
variable cute inductor, *see* vL
variable european inductor, *see* vL
varistor, 11

vC, *see* variable capacitor
VC*, *see* full varcap
vcc, 8
VCo, *see* empty varcap
vco, 17
vL, 15, 16
voltmeter, 9
vphaseshifter, 19
vpiattenuator, 19
vR, 10
vsourcesin, *see* sinusoidal voltage
source
vsourcesquare, *see* square voltage
source
vsourcetri, 16
vtattenuator, 19

wilkinson, 24

zD*, *see* full Zener diode
zDo, *see* empty Zener diode